

MOTORS WITH POWER UP TO 850 W

SP SERIES - Non reversible

WATT: 800 / CONSUMPTION: 1000 NI/1"

Data sheet
SP6D

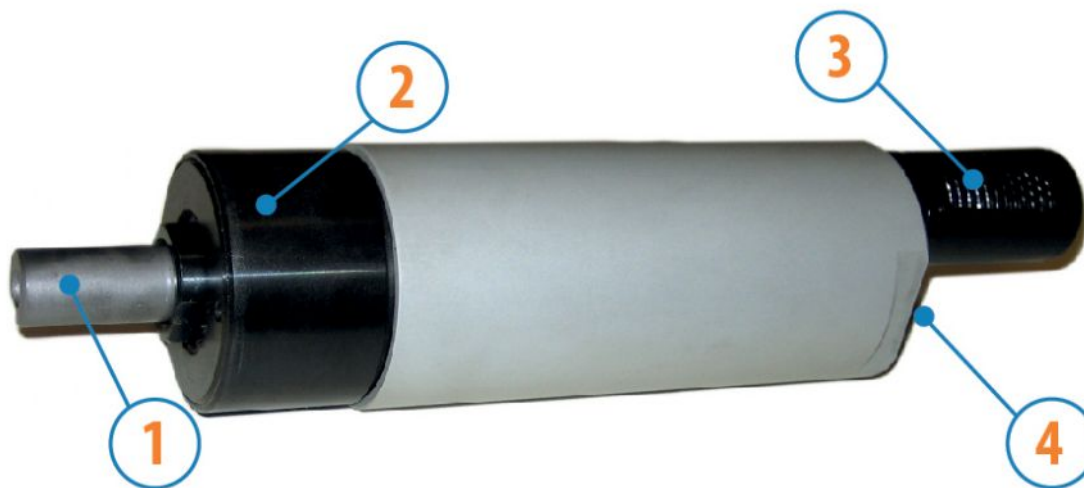

1. Cylindrical keyed shaft
2. Grip zone
3. Air inlet
4. Air exhaust

Technical specification

Right rotation - Model	SP6D
Right rotation - Code	8711255
Speed rpm - No-load	580
Speed rpm - at Max Power	285
Torque Nm - at Max Power	26,0
Torque Nm - Stall Torque	53,0

Form features

The normal delivery condition: cylindrical shaft and body as shown in the photo.

Optional:

Shaft

- threaded - indication /AF (left rotation excluded - subject to checks for reversible)

- conical - indication /AC

- with collets - indication /AP

Body

- with diamond flange coupling

Characteristic curves

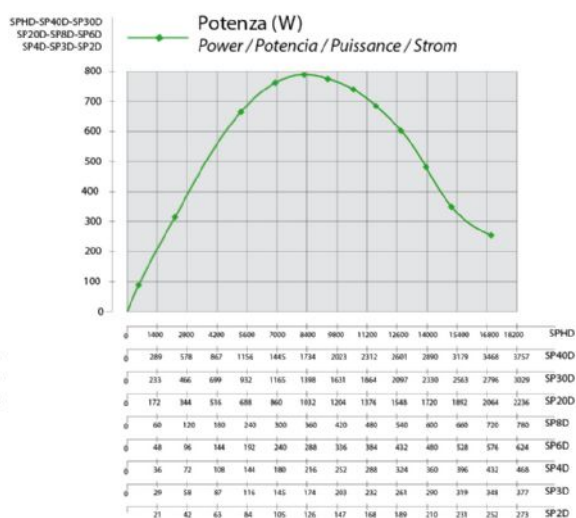
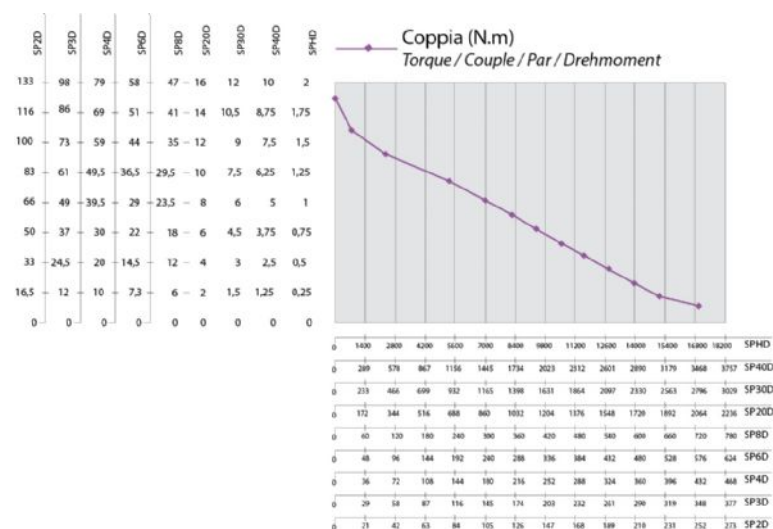

MOTORS WITH POWER UP TO 850 W

SP SERIES - Non reversible

WATT: 800 / CONSUMPTION: 1000 NI/1"

Data sheet
SP6D

Permissible radial and axial loads

Model	Code	Fr (N)	Fa (N)	Co (N)
SP6D	8711255	2050	2350	4750

Overall dimensions

Serie SP Non reversibili
Series SP Non-reversible
Serie SP Nicht umsteuerbar

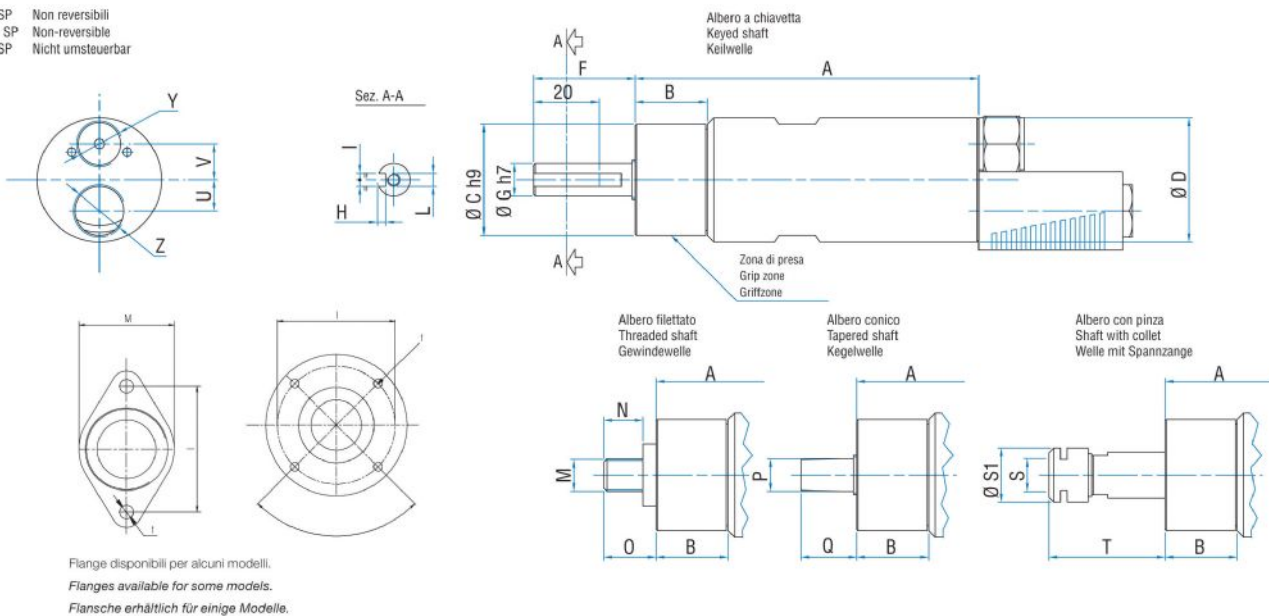

Model	Code	A	B	C	D	F	G	H	I	L	M	N	O	P	Q	S	S
SP6D	8711255	174	59	48	50	31,5	14	3	5	M6	1/2"x20UNF	16	20,5	B12	26	ER16	2