

# MOTORS WITH POWER UP TO 850 W

SP SERIES - Non reversible

WATT: 800 / CONSUMPTION: 1000 NI/1"

Data sheet  
**SP2D**

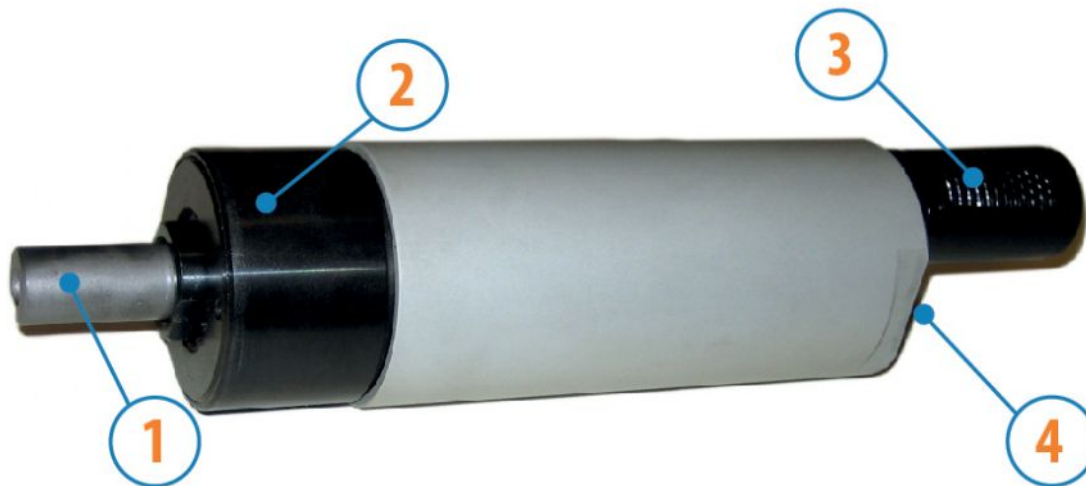

1. Cylindrical keyed shaft
2. Grip zone
3. Air inlet
4. Air exhaust

## Technical specification

Right rotation - Model	SP2D
Right rotation - Code	8711258
Speed rpm - No-load	250
Speed rpm - at Max Power	125
Torque Nm - at Max Power	59,0
Torque Nm - Stall Torque	120,0

## Form features

The normal delivery condition: cylindrical shaft and body as shown in the photo.

Optional:

Shaft

- threaded - indication /AF (left rotation excluded - subject to checks for reversible)

- conical - indication /AC

- with collets - indication /AP

Body

- with diamond flange coupling

## Characteristic curves

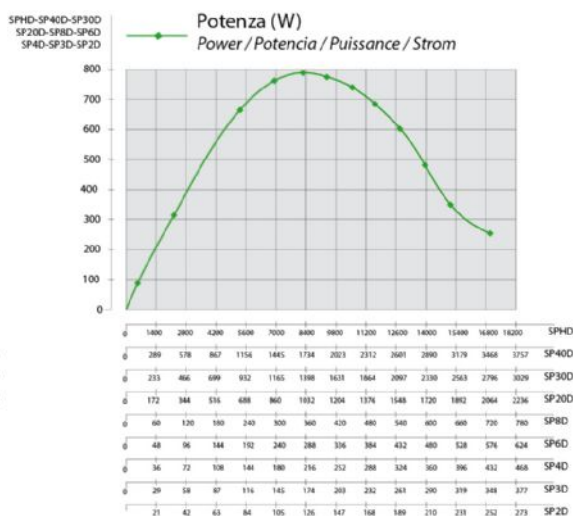
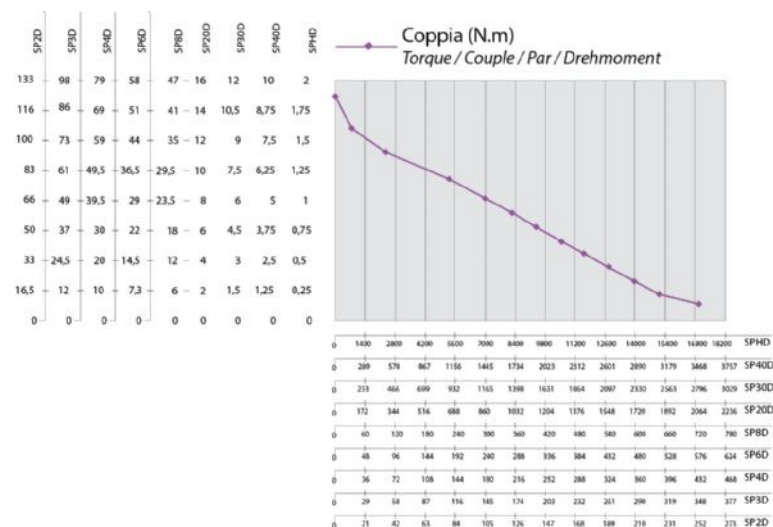

# MOTORS WITH POWER UP TO 850 W

SP SERIES - Non reversible

WATT: 800 / CONSUMPTION: 1000 NI/1"

Data sheet  
**SP2D**

## Permissible radial and axial loads

Model	Code	Fr (N)	Fa (N)	Co (N)
SP2D	8711258	2050	2350	4750

## Overall dimensions

Serie SP Non reversibili  
Series SP Non-reversible  
Serie SP Nicht umsteuerbar

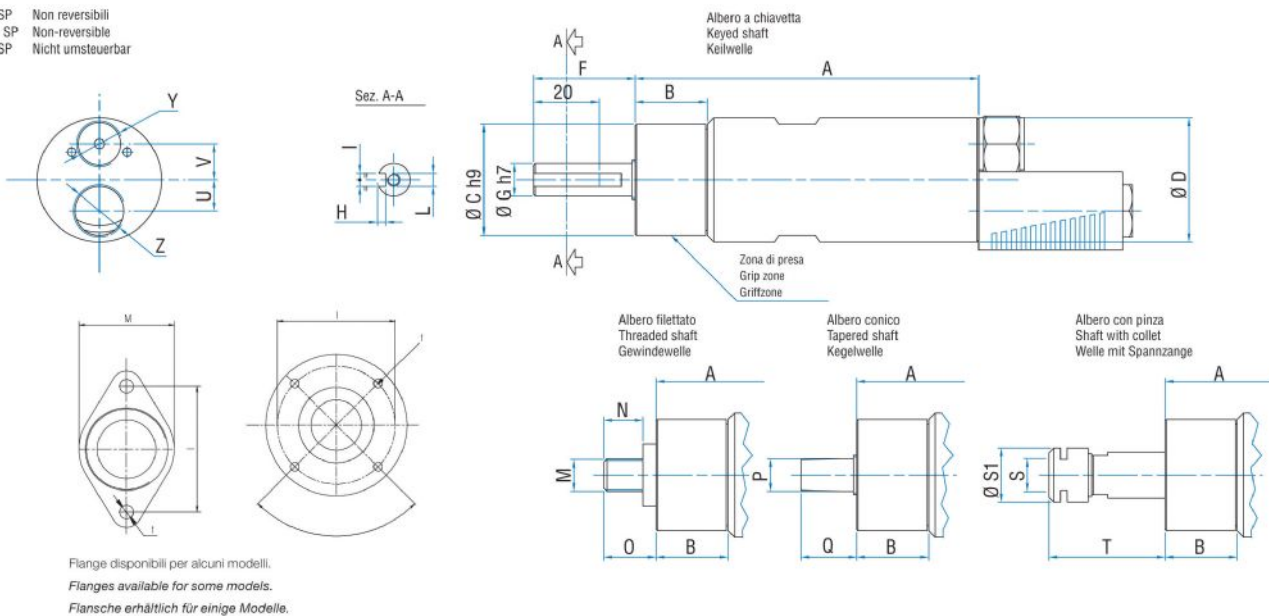

Model	Code	A	B	C	D	F	G	H	I	L	M	N	O	P	Q	S	S
SP2D	8711258	174	59	48	50	31,5	14	3	5	M6	1/2"x20UNF	16	20,5	B12	26	ER16	2