

MOTORS WITH POWER OVER 1000 W

NK SERIES - Non reversible

WATT: 3100 / CONSUMPTION: 2800 NI/1"

Data sheet
NK150S

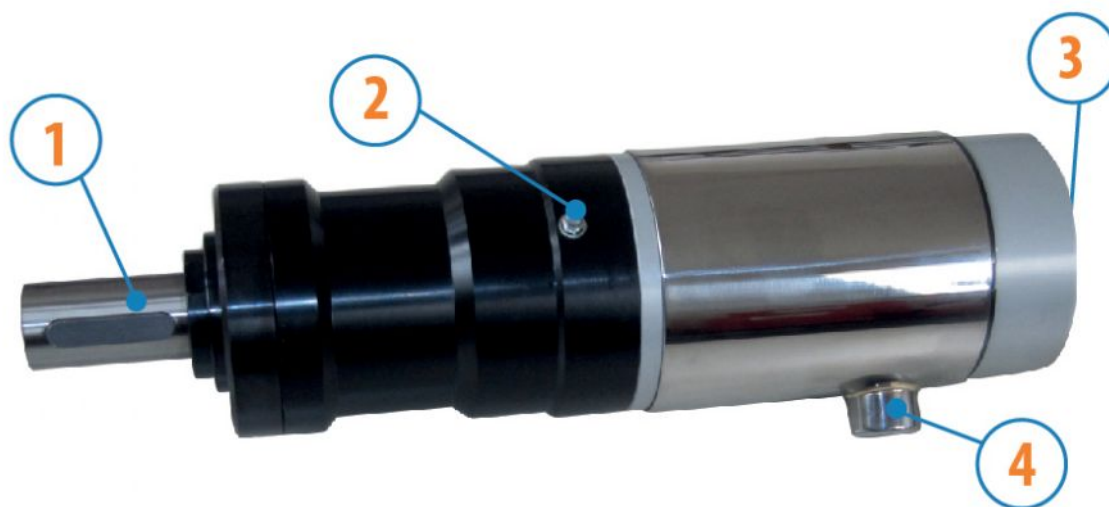

1. Cylindrical keyed shaft
2. Grease gun
3. Air inlet
4. Air exhaust

Technical specification

Left rotation - Model	NK150S
Left rotation - Code	8721262
Speed rpm - No-load	150
Speed rpm - at Max Power	110
Torque Nm - at Max Power	267
Torque Nm - Stall Torque	650

Form features

The normal delivery condition:
cylindrical shaft and body as shown in the photo.

Optional:

Shaft

- threaded - indication / AF (left rotation excluded - subject to checks for reversible)

- conical - indication / AC

- with collets - indication / AP

Characteristic curves

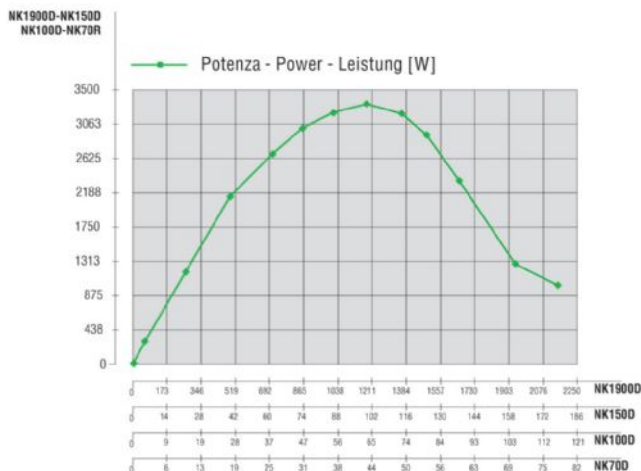
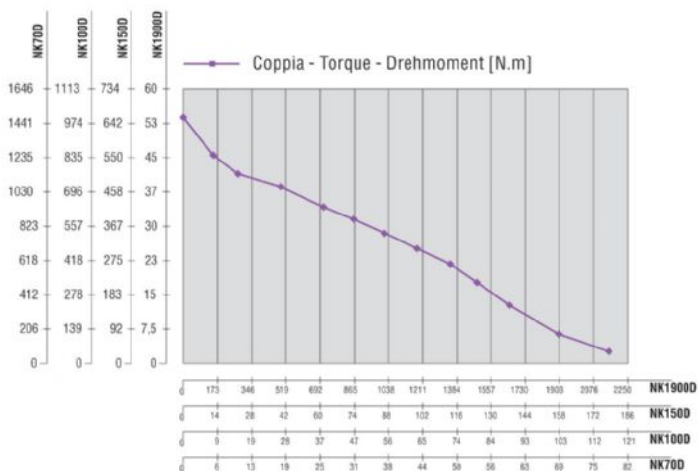

MOTORS WITH POWER OVER 1000 W

NK SERIES - Non reversible

WATT: 3100 / CONSUMPTION: 2800 NI/1"

Data sheet
NK150S

Permissible radial and axial loads

Model	Code	Fr (N)	Fa (N)	Co (N)
NK150S	8721262	11000	8000	54000

Overall dimensions

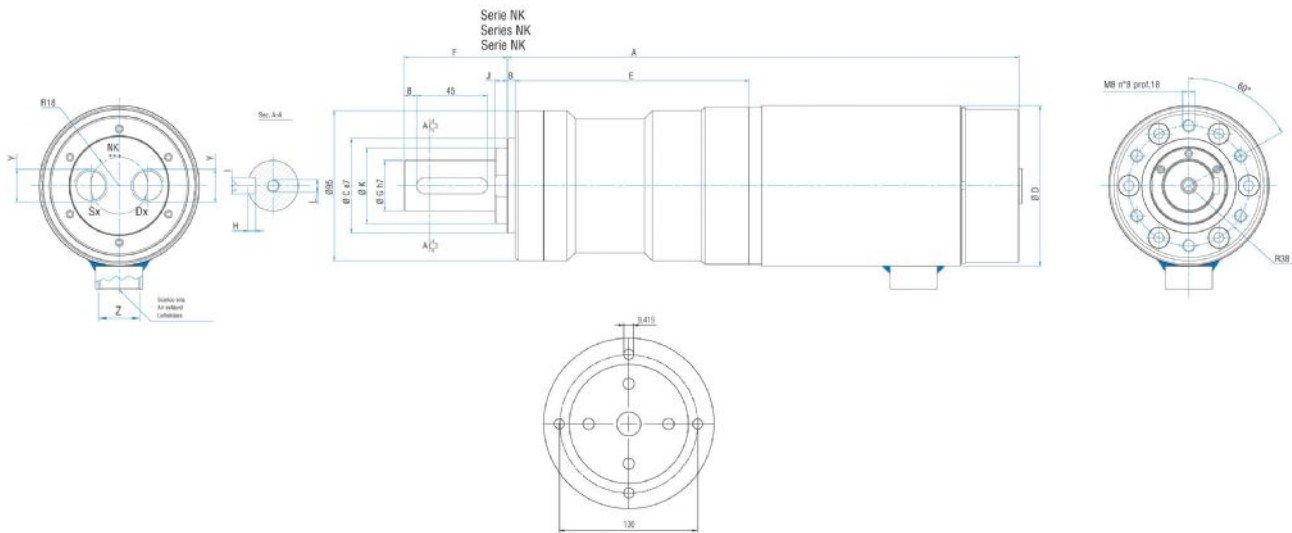

Flange disponibili per alcuni modelli.
Flanges available for some models.
Flansche erhältlich für einige Modelle.

Model	Code	A	B	C	D	E	F	G	H	I	J	K	L	Y	Z
NK150S	8721262	331,8	5	60	101,6	148,3	65,5	32	5	10	7,5	48	M8	1/2"	3/4"