

MOTORS WITH POWER OVER 1000 W

LKW SERIES - Non reversible

WATT: 1340 / CONSUMPTION: 1400 NI/1'

Data sheet
LKW02S



1. Cylindrical keyed shaft
2. Grease gun
3. Air inlet
4. Air exhaust

Technical specification

Left rotation - Model	LKW02S
Left rotation - Code	8721245
Speed rpm - No-load	190
Speed rpm - at Max Power	90
Torque Nm - at Max Power	137,5
Torque Nm - Stall Torque	163,3

Form features

The normal delivery condition: cylindrical shaft and body as shown in the photo.

Optional:

Shaft

- threaded - indication / AF (left rotation excluded - subject to checks for reversible)

- conical - indication /AC

- with collets - indication / AP

Characteristic curves

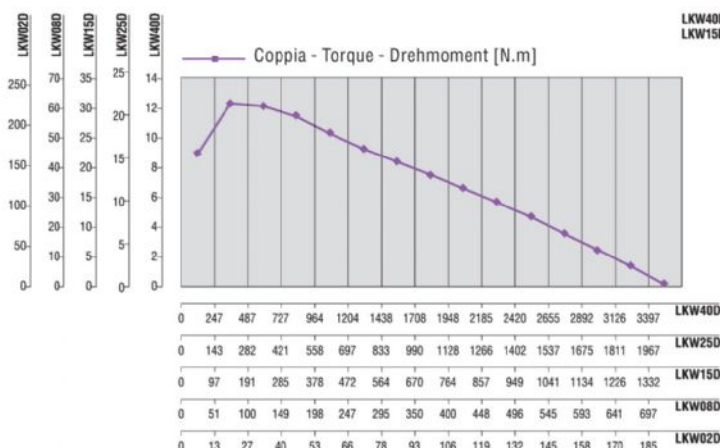

MOTORS WITH POWER OVER 1000 W

LKW SERIES - Non reversible

WATT: 1340 / CONSUMPTION: 1400 NI/1'

Data sheet
LKW02S

Permissible radial and axial loads

Model	Code	Fr (N)	Fa (N)	Co (N)
LKW02S	8721245	2850	3900	7800

Overall dimensions

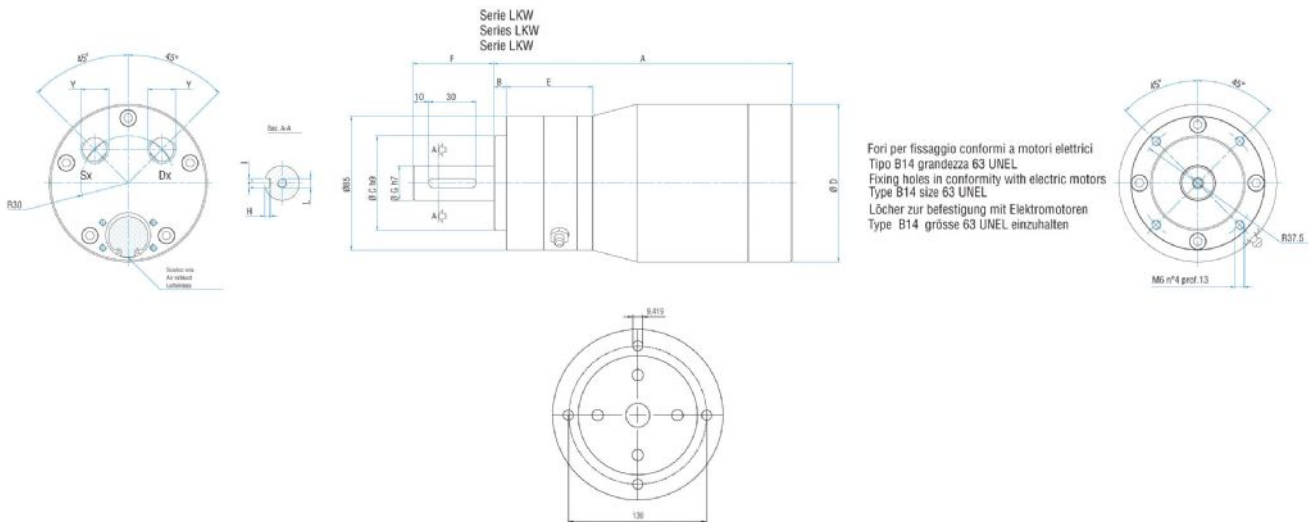

Fori per fissaggio conformi a motori elettrici
Tipo B14 grandezza 63 UNEL
Fixing holes in conformity with electric motors
Type B14 size 63 UNEL
Löcher zur Befestigung mit Elektromotoren
Type B14 grösse 63 UNEL einzuhalten

Flange disponibili per alcuni modelli.
Flanges available for some models.
Flansche erhältlich für einige Modelle.

Model	Code	A	B	C	D	E	F	G	H	I	J	K	L	Y	Z
LKW02S	8721245	238,2	8	60	100	103,8	51,2	22	3,5	6	/	/	M6	3/8"	/